

Power Port 8PTC Installation Note

The Power Port 8PTC is an expandable module designed to provide protected power distribution for building electronic access control and security devices.

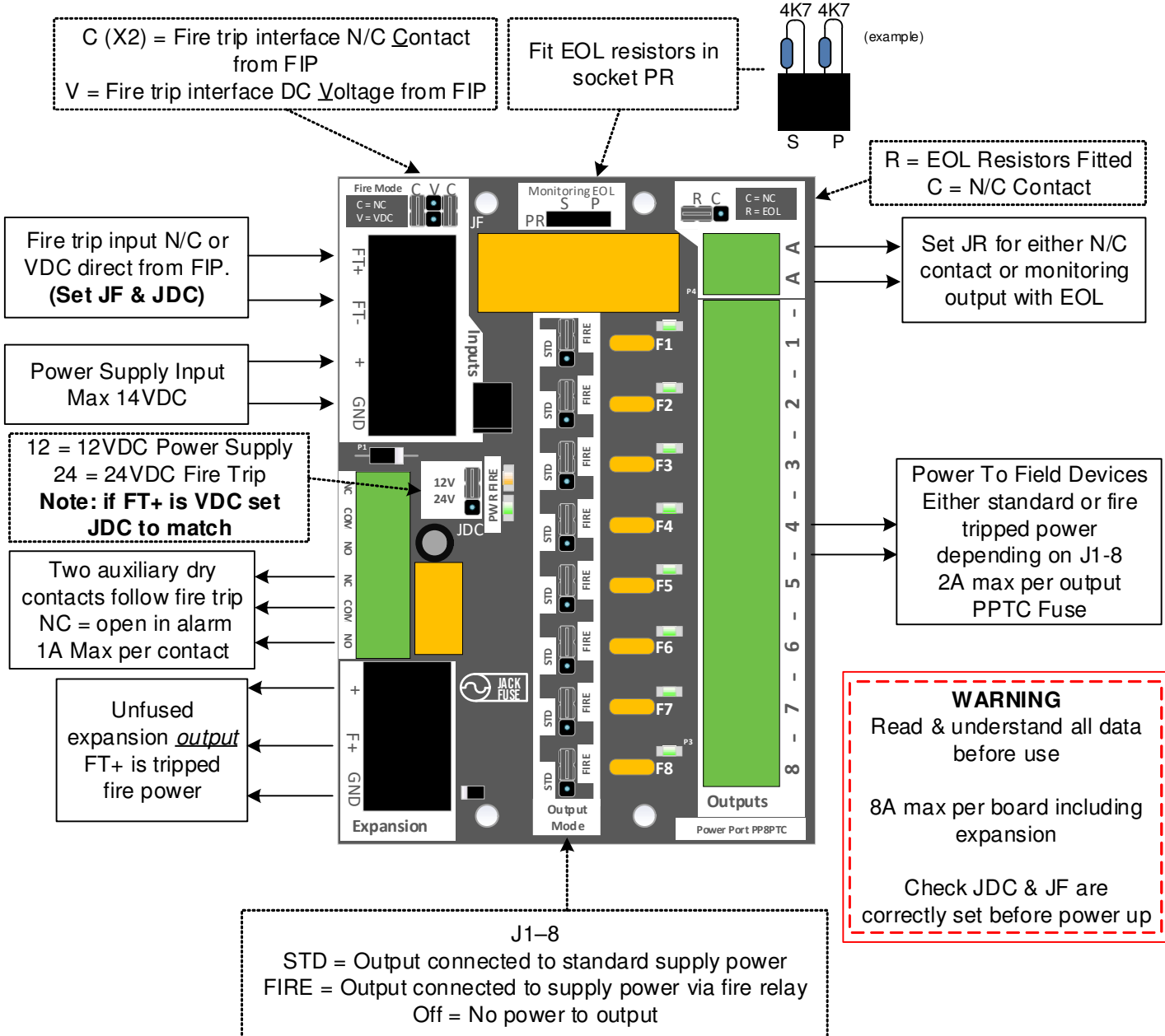

Mounting

The PP8PTC is fitted with two DIN rail mounting clips that suit most popular top hat and G profile rails. For low profile enclosures the PP8PTC is also suitable for the popular "Snap Track" mounting method. (TE Connectivity, part number 4TK2)

Settings

Warning: It is important to correctly set and check JF and JDC before applying fire trip or power to the PP8PTC module. Incorrect jumper settings may cause damage to the module and other equipment.

Jumper/Link	Position	Description
J1-8	S	Associated output connected to standard supply power
	F	Associated output connected to supply power via fire relay
	Off	No power available to associated output
JR	C	Terminal A – A provides N/C fire relay contact
	R	Terminal A – A provides fire relay status monitoring via EOL resistors
JF	C (x2)	Fire trip interface normally [C]losed contact in fire panel
	V	Fire trip interface DC [V]oltage from fire panel
JDC	12V	12VDC Fire trip input (or 12V supply input for NC trips)
	24V	24VDC Fire trip input (or 24V supply input for NC trips)

Fire Trip Interface

The on-board fire relay is designed to provide a failsafe method of fire trip interface. There are two options for connection to the FIP. (Fire Indication Panel.) A normally closed, voltage free contact can be used. Alternatively, the FIP or another device can supply a DC voltage. Both options are terminated directly to the FT+ and FT- terminals and links set to match (see section 3). Correct voltage polarity must be observed.

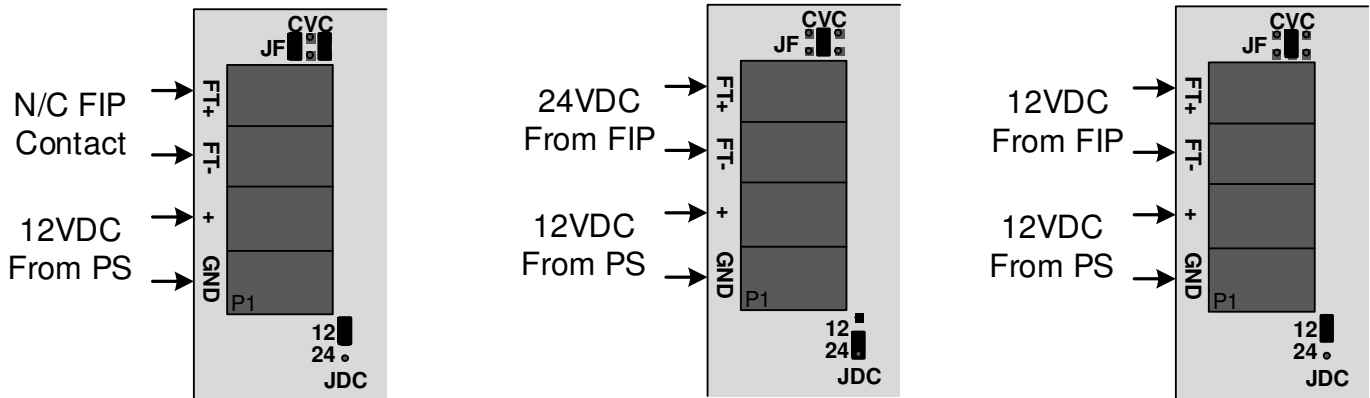

If an N/C fire trip is used, care must be taken to set JDC to the value of the power supply input as this will be used to activate the fire relay.

Alarm Contacts & Trip Monitoring

The terminals marked A - A are interfaced to the secondary contact of the fire relay. By setting JR to C, the terminals A - A provide an N/C contact for expansion or alarm monitoring (Maximum 2A)

By setting JR to R and installing EOL (End Of Line) resistors into the sockets marked PR, the terminals A - A provide a direct interface to a security panel input without the need to join or solder resistors. Resistor leads should be bent and trimmed to 6-8mm below resistor base. See examples in diagram below. (P = Parallel EOL resistor, S = Series EOL resistor)

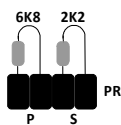

Different EOL Resistors

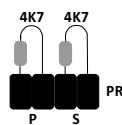

Same EOL Resistors

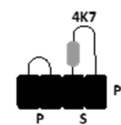

Single EOL Resistor

Trips to other Equipment. Often there will be other equipment requiring a fire trip such as automatic doors. The PP8PTC has two auxiliary, dry contact, double throw outputs (P5) that are slaved to the fire trip. These can be used to trip other equipment.

Expansion

A common expansion option shown below. **Note.** Total current drawn through the PP8PTC from power supply must not exceed 8A. This includes total via all outputs and expansion terminals. If expected current is more than 8A, use a second PP8PTC with direct feed from power supply and not via expansion terminals of PP8PTC.

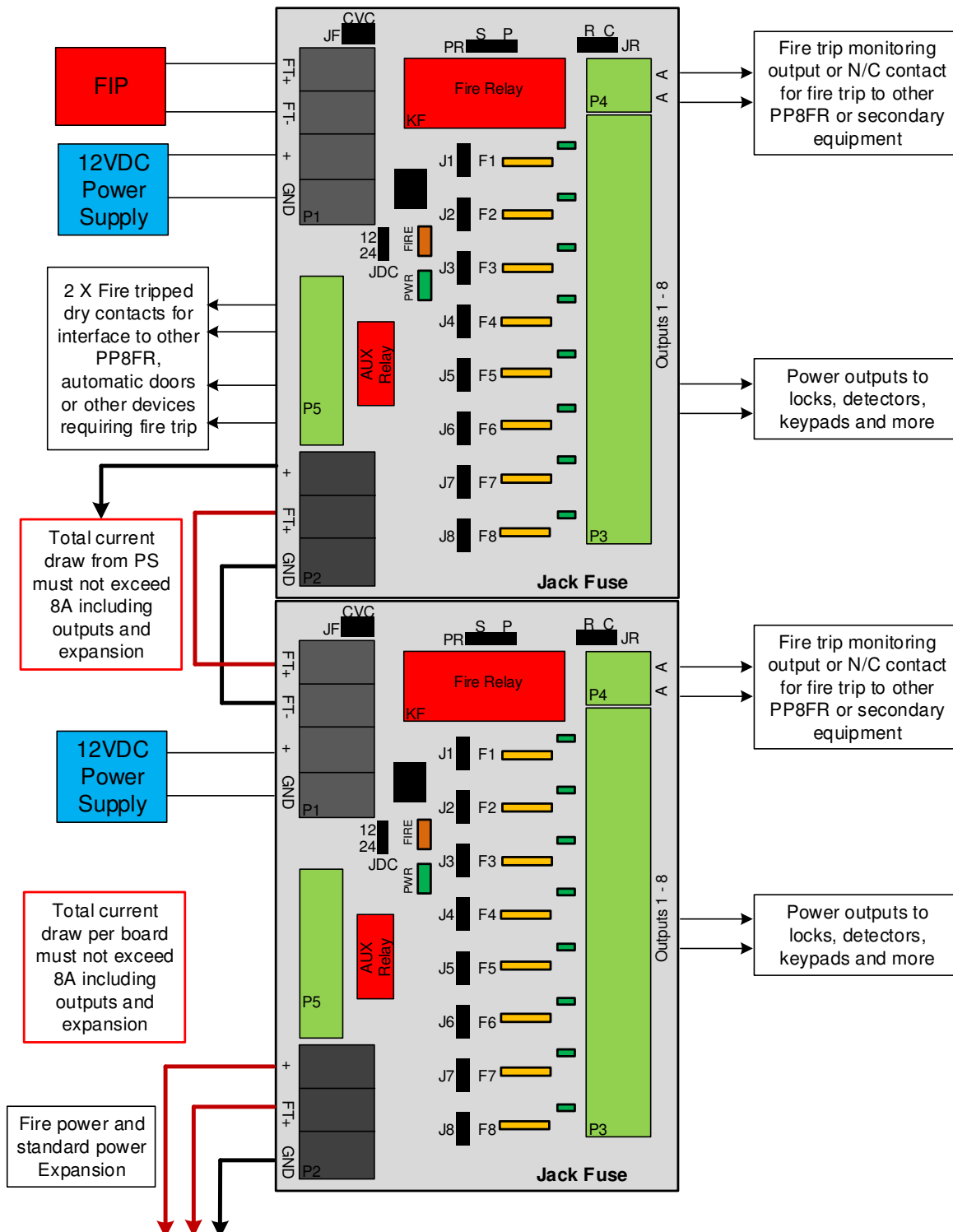

Output expansion. Additional fused power outputs can be added using the expansion boards PP10HD or PP10MG. One or more boards can be added if the total current draw via the PP8PTC does not exceed the PCB or fire relay limit of 8A. If current draw exceeds limitations an additional PP8PTC module can be used.

Fire Trip to Additional Modules

A normally closed fire trip signal from the fire panel can not be used to directly trip more than one PP8PTC/8FR module. To replicate the fire trip to additional PP8PTC/8FR modules, Jack Fuse recommends powering all subsequent fire trips from the P2 FT+ expansion output of the first module. Remember to set JF to voltage (V - V) for the downstream modules.

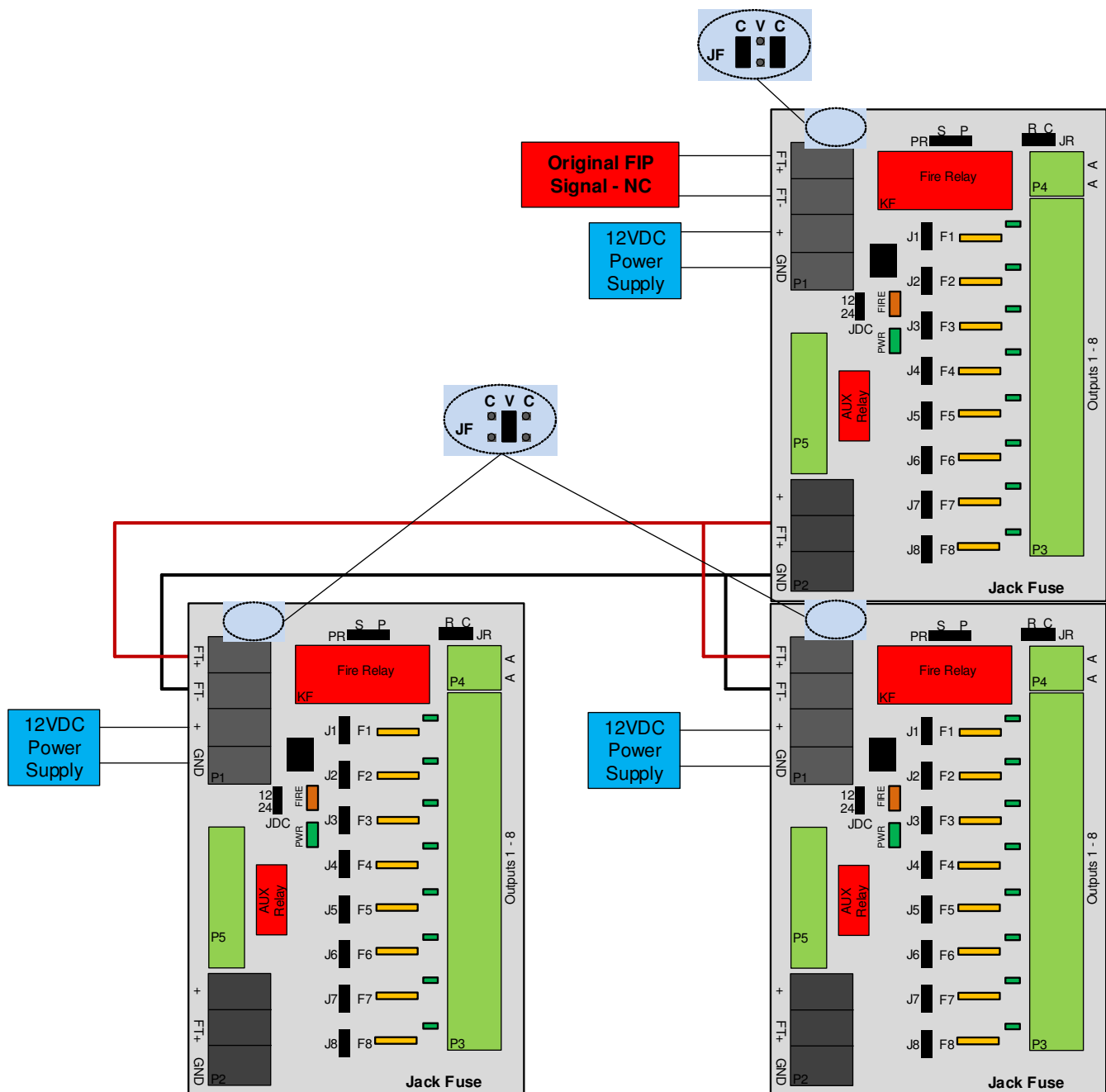

Technical Data

Input voltage range	0-14V DC
Fire relay coil voltage	12-28V DC (or dry contact)
Max standard power current	8A
Max fire power current	8A*
Max constant current per output	2A
Fused outputs	8
Fuse type	2A Self-healing PPTC
Mounting	DIN rail
Dimensions	110 L X 75 W X 52 H (mm)
Country of origin	Australia

*Peak current only – resistive load. A 20% load current margin is recommended for fire power current (6.4A). Many devices, including electric locks, have a higher current on start-up and at other times; this must be accounted for in the peak current. Current ratings are valid for operating temperatures up to 24 degrees C with a fire trip of 12VDC. Factors such as lock types, external heat and higher fire trip voltages must be considered when designing power loads.

Connections

Terminal	Description	Max Conductor Size
P1 – FT- FT+	Fire panel trip interface	2mm ²
P1 – GND & +	DC Power supply input	2mm ²
P2	Expansion Output	2mm ²
P3 1 - 8	Fused outputs	1.5mm ²
P3 A-A	Monitoring/output	1.5mm ²
P5 NC/COM/NO	Aux Dry Contacts	1.5mm ²
PR	EOL Resistor Sockets	¼ - ½ Resistors X 2

Indicators

LED Designator	Description
D1-8	Fuse status, "on" indicates fuse intact and power is available.
DF	Fire relay status, "on" indicates relay is active and fire power is available.
PWR	Power is available from the power supply.

Ordering Code

PP8FR	Power Port 8FR supplied with a din rail mount kit, fire relay and 8 X 1A glass fuses.
PP10MG	Power Port 10MG supplied with a din rail mount kit and 10 X 1A glass fuses
PP8PTC	Power Port 8PTC supplied with a din rail mount kit, fire relay and 8 X self-healing fuses.
PP5FR-UNI	Power Port 5FR-UNI, mounts in Gallagher and Inner Range module footprints. 5 X Self-healing fuses. Din rail mount kit optional.
PP10HD	Power Port 10HD supplied with a din rail mount kit and 10 X 1A self-healing fuses

Learning

Become a **Jack Fuse Product and Power Certified Technician**. Free training available online.

More Information: For complete installation notes, data sheets and technical support please visit www.jackfuse.com

