



Mini-FRI Field Relay Interface

Installation Note

A miniature relay for interface to security and other equipment

Converts a DC voltage signal into a single pole double throw dry contact.

12 and 24VDC models available.

Quick Guide

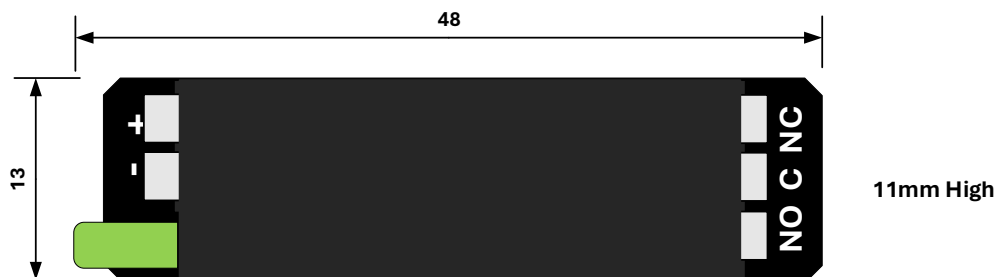
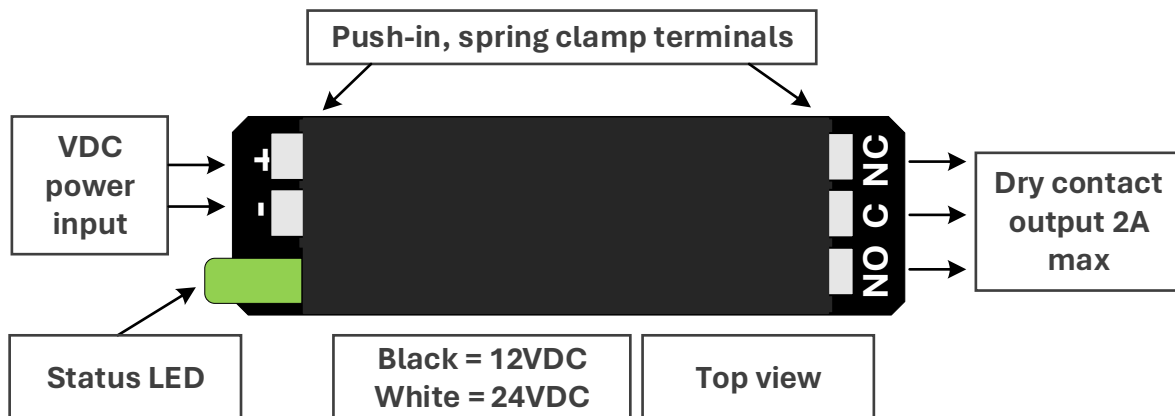

Termination

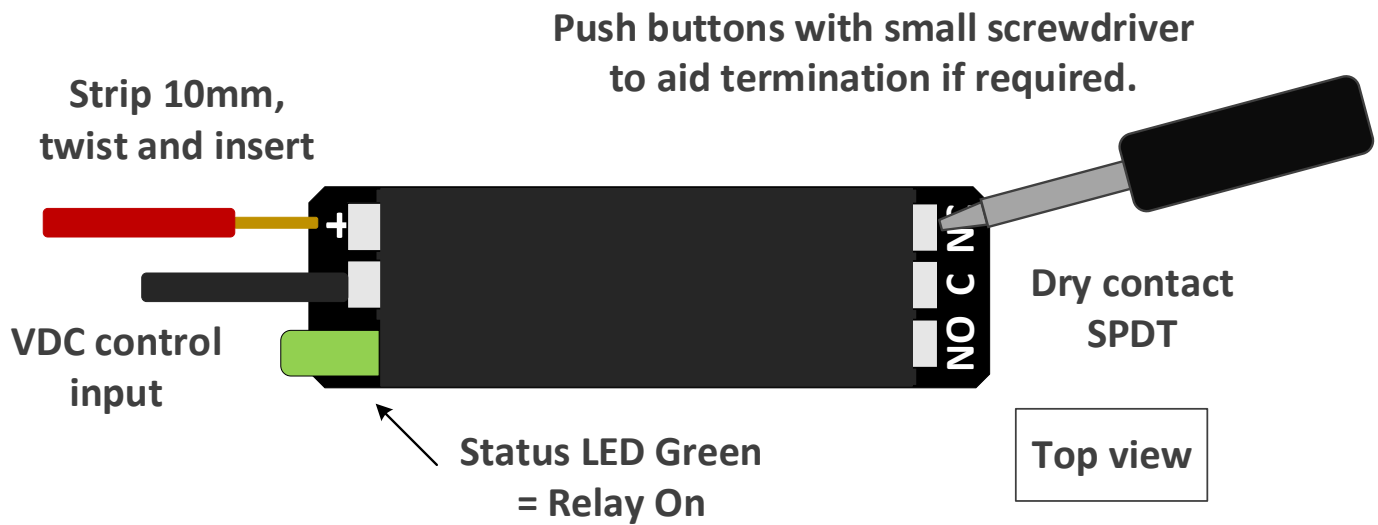

Installation

The Mini-FRI uses secure, push in, spring clamp terminals. Strip the sheath from the conductor approximately 10mm, twist stranded conductors tightly and push into the appropriate terminal. For most cable types, no screwdriver will be required.

For thin or flexible conductors, the white buttons above each terminal can be pushed to open the connection to aid termination.

Take care to terminate the VDC connection with the correct polarity.

An upstream fuse is recommended for the VDC supply. The fuse should be sized to protect the cable. A 1-2A fuse rating is suitable for most security cables.

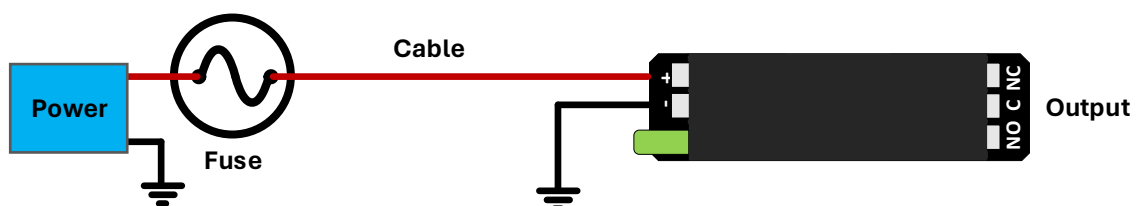

Mounting

The Mini-FRI can be used as an inline device and does not need to be mounted. To keep the Mini-FRI in place it is acceptable to use a cable tie around the centre of the module. The LED indicator is most easily seen from the power/coil end of the Mini-FRI.

Removal

De-termination is achieved by pressing the buttons above each conductor and gently pulling one wire at a time. The Mini-FRI can be re-used multiple times.

Operation

Relay Coil

The relay coil is powered via the terminals marked + and -. Apply a DC voltage to energise the relay. An energised relay is indicated by an illuminated green LED.

The Mini-FRI has both reverse polarity and energy kick back protection diodes on board.

Relay Contacts

A Single Pole Double Throw (SPDT) also known as a 1 Form C configuration is used for the relay contacts. The relay contact terminals are marked NC, C and NO. The normally closed (NC) contact is closed and connected to the common (C) terminal when the Mini-FRI is unpowered.

Once power is applied this contact changes over and the normally open (NO) contact is then connected to the common terminal.

Typical Connections

The Mini-FRI can be used in most situations where a relay/dry contact interface is required.

Common uses include, but are not limited to:

Operating a powered swing door controller from the access control system.



Converting a low current transistor output to a high current dry contact.

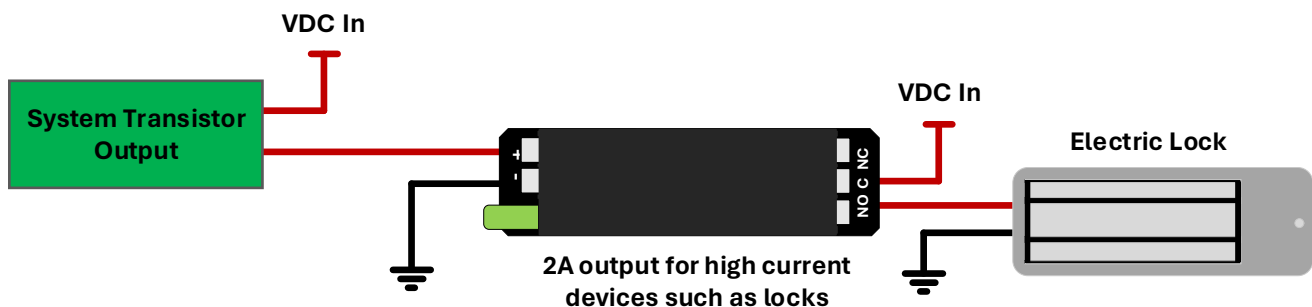

Alarm monitoring of a voltage/power circuit.

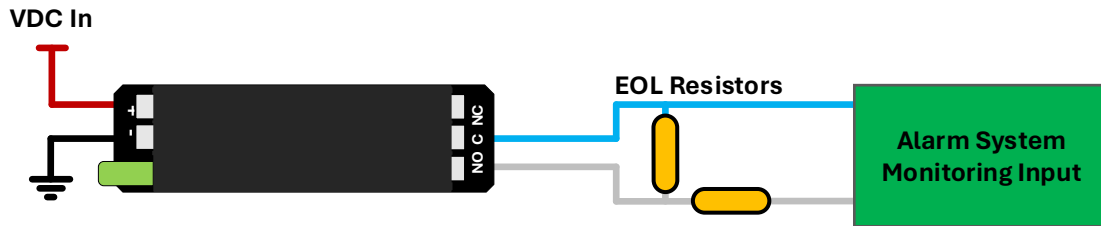

Circuit Diagram (Simplified)

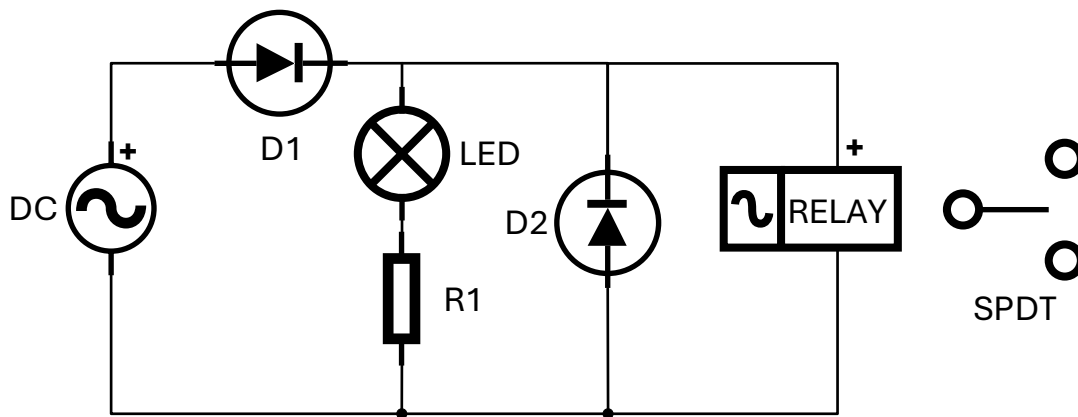

Technical Data

Conductor size	.2 - 1.5mm ² (24-16AWG)
Relay contact max current	2.2A @ 5-30VDC
Relay contact configuration	SPDT (1 Form C)
Coil current draw	25mA @ 13.8VDC (.35W)
Coil operating voltage (Mini-FRI-12)	8-15 VDC*
Coil operating voltage (Mini-FRI-24)	20-35 VDC*
Suitable for stranded conductors	Yes
Suitable for solid conductors	Yes
Dimensions L X W X H	48X13X11mm
RoHS	Compliant
AUS/NZ (RMC-EMC) 61000.6.3	Compliant
Primary materials	Polyamide 46, fiberglass, polyolefin
Country of origin	China

*Drop out voltages may exceed stated values.

Ordering Code

Mini-FRI-12	Black – Field relay interface for use with 12VDC systems
Mini-FRI-24	White – Field relay interface for use with 24VDC systems

Learning

Become a **Jack Fuse Product and Power Certified Technician**. Free training available online.

More Information: For complete installation notes, data sheets and technical support please visit www.jackfuse.com